

# duux®

DESIGNED FOR BETTER AIR



Consumenten  
bond

**BESTE UIT  
DE TEST**

APR 2022



# Breathe life into your home.

Duux has been the specialist in air treatment for twenty years. We believe in the importance of a clean and healthy living environment for everyone. Our products ensure healthy and comfortable indoor air, all year round. Pleasant to breathe and good for your health! With eye-catching designs, Duux products blend perfectly into any interior. Pure Dutch Design with international appeal: our products are currently available in more than 30 countries.

## The importance of healthy air

We improve your health through air! A healthy lifestyle immediately makes you think of enough exercise and a healthy diet. But did you know that many health problems are related to poor air quality? On average, we spend 90% of our time indoors, where the air quality is up to five times worse than outdoors. Complaints such as fatigue, headaches, dry skin, colds and concentration problems are often due to poor indoor air quality. And when you consider that you breathe 20,000 times a day, it is indeed important to pay attention to air quality.



INDOOR AIR QUALITY IS  
5 TIMES MORE  
POLLUTED THAN OUTSIDE



WE BREATHE 20.000  
TIMES A DAY, THAT'S  
10.000 LITERS OF AIR



WE SPENT 90% OF  
OUR TIME INDOORS  
(HOME AND OFFICE)



9 OUT OF 10 PEOPLE  
LIVE IN BAD AIR  
QUALITY CONDITIONS

# We promise to keep you cool and sleep with piece of mind.



Our Whisper fan range is internationally awarded for being **extremely quiet** and **energy efficient**.



Our air purifiers have the **highest filter grades** and **CADR ratings**, tested by renowned German institute IUTA.



Our new North 9K mobile air conditioner is able to **cool and heat** and is the **most quiet** mobile airco in its class.



Most of our assortment is compatible with **Duux Smart Home** to keep you on top of your air quality, always and anywhere.



We keep 120+ spare parts and accessories available at **[duux.com/spare-parts](https://duux.com/spare-parts)** for easy upgrades and maintenance.





SMART HOME COMPATIBLE

DXMA26 - 12K Dark gray | DXMA10/11 - 14K Dark gray/White | DXMA12/13 - 18K Dark gray/White

# North

SMART MOBILE AIRCO

## A blast of arctic bliss. Welcome North

Do brutally hot summer temperatures have you dreaming of the polar ice caps? Now you can bring that winter wonderland home, minus the snow and ice. Introducing North, a mobile air conditioner that will ease your summer woes. With a high cooling capacity of 18K BTU/h\*, a North wind can cool off even the largest rooms. It's WiFi enabled for voice and smartphone control with the free Duux Smart app. So bring on the heatwave. North is waiting.

- 18K\***  
BTU/H  
COOLING
- 65M<sup>2</sup>**  
MAX. EFFECTIVE  
AREA
- R290**  
ECO-FRIENDLY  
GAS



### Cool, pretty *and* smart

With a cooling capacity of 18K BTU per hour, using environmentally friendly refrigerant (R290), North creates an air flow of 450m<sup>3</sup> per hour. Its PET filter captures large dust particles, helping to clean the air in the room, and the Night Mode is wonderfully quiet (55dB.)

## Features and specifications

- 18.000 BTU/h\* cooling capacity
- 5000W cooling performance
- 450m<sup>3</sup>/h air flow
- Up to 65m<sup>2</sup> effective area
- 1-24h timer
- 4 operation modes incl. night
- R290 refrigerant
- Digital LED touch display
- Including remote control
- Including flexible window kit

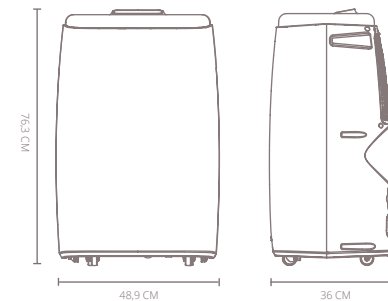

\* = Also available in 12/14K BTU/h - 44 x 36 x 69.7 cm (DXMA10/11/26)



SMART HOME  
COMPATIBLE

# North 9k

SMART MOBILE AIRCO  
COOLING & HEATING

Deliciously comfortable  
all night long

It's hot. It's sticky. You lie in bed and wish your windows could open even further to catch a hint of breeze. Suddenly, a delicious wind blows in — North 9K. This quiet mobile air conditioner has transformed your room into the definition of cool. So shut out the heat and drift off to dreamland. And don't worry about cold feet in the winter: with its heating function, North keeps your room wonderfully warm on colder days.



**9K**  
BTU/H  
CAPACITY

**33M<sup>2</sup>**  
MAX. EFFECTIVE  
AREA

**R290**  
ECO-FRIENDLY  
GAS

Beautifully cool (and quiet)

Shut the windows on the heat and noise outside and enjoy the coolness and sleek, modern design of North 9K. The beautiful light gray matte finish fits in perfectly with any decor. And at 40dB, North is surprisingly quiet for a mobile air conditioner

## Features and specifications



9,000 BTU/h  
cooling capacity



2300W  
cooling performance



340m<sup>3</sup>/h air flow



Up to 33m<sup>2</sup>  
effective area



1-24h timer



5 operation  
modes incl. night



R290 refrigerant



Digital LED  
touch display



Including  
remote control



Including flexible  
window kit

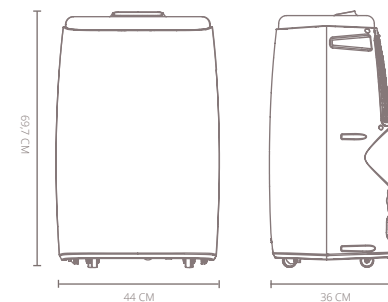



DXMA04 - 10K | DXMA05 - 12K

# Blizzard

SMART MOBILE AIRCO

## Your cool smart sidekick on hot summer days

Unproductive working days, sweaty dinners or sleepless nights. Summers are getting longer and hotter each year, meaning it's time for a new best friend that will make those days a lot more enjoyable. Meet Blizzard: a smart mobile airco with front output for extra efficient cooling. Its unconventional design makes it a true eyecatcher, and the wheels and handles on both sides allow you to move it wherever you want. So you will always stay cool.

**12K\***  
BTU/H  
COOLING

**44M<sup>2</sup>**  
MAX. EFFECTIVE  
AREA

**R290**  
ECO-FRIENDLY  
GAS



### Mobile, high-performance

Blizzard may be a mobile air-conditioning unit, but don't be fooled by its modest size – it has a cooling capacity of 12K BTU per hour\*. It can be used in any space up to 44m<sup>2</sup> – perfect for your bedroom, home office or living room.

## Features and specifications

- 12.000 BTU/h\* cooling capacity
- 3400W cooling performance
- 410m<sup>3</sup>/h air flow
- Up to 44m<sup>2</sup> effective area
- 0-24h timer
- 4 operation modes incl. night
- R290 refrigerant
- Digital LED touch display
- Including remote control
- Including flexible window kit

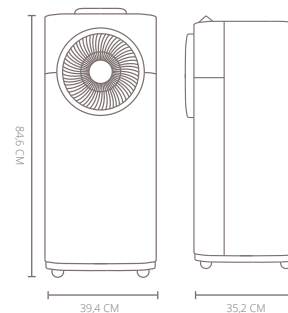

\* = Also available in 10K BTU/H (DXMA04)



SMART HOME COMPATIBLE





DXCF14 Black | DXCF15 White

# Whisper Flex Ultimate

SMART WIRELESS FAN

## Immerse yourself in an oasis of coolness and quiet

Imagine a cooling breeze that follows you through your home wherever you go. Bringing blissfully fresh air into every corner of your hot, stuffy house and transforming it into an oasis of coolness. Introducing Whisper Flex Ultimate: an incredibly versatile, energy efficient and powerful fan that can be adjusted to your perfect temperature while remaining whisper quiet. And it goes everywhere you do, with a 12 hour rechargeable battery providing wireless mobility throughout your entire home and beyond.



### Quiet as a whisper with a powerful reach

Thanks to its double fan blades, this energy efficient fan has 17 meters of wind reach. Its multi-directional oscillation rotates in both directions: an impressive 90° horizontal and 105° vertical tilt with three intermediate settings each. In night mode, the display automatically dims - ensuring you are not disturbed.

## Features and specifications

- Digital LCD display
- Natural wind and night mode
- 30 speeds
- Temperature controlled speed
- Horizontal and vertical oscillation
- Including battery pack (up to 12 hours usage)
- 1-12 hour timer
- Including remote control

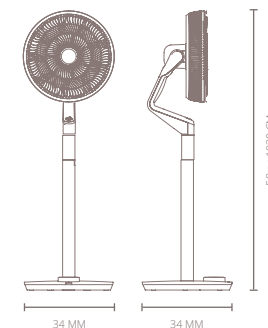



DXCF10 Black | DXCF11 White | DXCF19 Gray | DXCF12 Black (+BP) | DXCF13 White (+BP) | DXCF20 Gray (+BP)

# Whisper Flex

SMART PORTABLE FAN

## The ultimate smart fan that follows you anywhere

Meet Whisper Flex: the wireless wonder. This fan comes with a free smartphone app and optional battery pack that allows you to use and move it absolutely anywhere you want - whether it's your bedroom or that spot in the garden where you like to read. It's adjustable in height, seamlessly transforming from a desk model into a floor model with a horizontal and vertical swing. The best thing? It's whisper quiet - so you can focus on that page-turner or a restful night's sleep.



### Uncompromised performance

Whisper Flex is a real all-rounder. It has 26 speed settings, consumes little energy and has a powerful motor with double fan blades. On top of that, the horizontal and vertical swing ensure every direction of the room is reached with minimal noise production.

## Features and specifications

- Digital LCD display
- Natural wind and night mode
- 26 speeds
- Optional battery pack (included with DXCF12/13/20)
- Horizontal and vertical oscillation
- Double fan blades
- 1-12 hour timer
- Including remote control

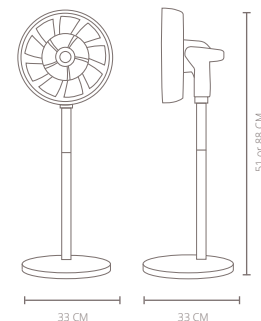



# Whisper

FAN

## Dreaming away with a natural wind

Meet the fan that surprises you with a gentle breeze, a strong gust of wind and everything in between. The Duux Whisper has no less than 26 speeds so you will always find the perfect one for you. And it does not matter where you go in the room, because thanks to the horizontal and vertical oscillating function it brings a pleasant coolness everywhere.

13dB  
WHISPER  
QUIET

15M  
WIND  
REACH







2W  
ENERGY  
EFFICIENT

### Multiple speeds and directions

Whisper lives up to its name and is one of the quietest fans of its kind. The little noise which is produced is reminiscent of the wind that you hear rustling outside. You can easily switch between different wind speeds and air flow directions. It is also height adjustable to suit as table or floor model.



## Features and specifications

-  Digital LCD display
-  Natural wind mode
-  26 speeds
-  Night mode
-  Horizontal and vertical oscillation
-  Double fan blades
-  1-12 hour timer
-  Including remote control

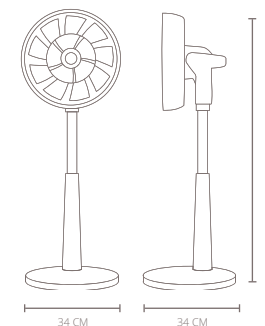

# Globe

TABLE FAN

## The multi-talented rotating fan

With its modern design, Globe looks good on any table, desk or kitchen top. But its beauty goes beyond what's on the outside. This table fan has a powerful DC motor with a reach of 7 meters, maximized by its horizontal (90°) and vertical (80°) oscillation. This refreshingly unique feature makes sure the fan covers an impressively wide area - for optimal comfort throughout the whole room.



**13dB**  
WHISPER  
QUIET









**7M**  
WIND  
REACH

**2W**  
ENERGY  
EFFICIENT

### Full power, low energy consumption

Globe has been fitted with a powerful DC motor, which guarantees an impressive reach of 7 meters. That must require a lot of energy, right? Not at all! The table fan consumes only 2W in the lowest speed setting.

## Features and specifications

-  Powerful DC motor
-  Touch controls
-  3 speeds
-  1 and 3 hour timer
-  90° horizontal oscillation
-  LED status indicators
-  80° vertical oscillation
-  Including remote control

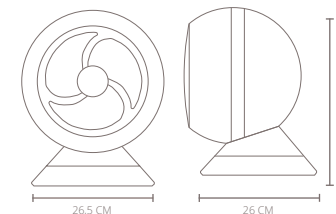

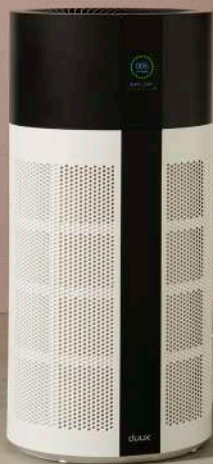

DXPU03

# Tube

SMART AIR PURIFIER



**110M<sup>2</sup>**  
MAX. EFFECTIVE AREA

**550M<sup>3</sup>**  
PER HOUR CADR

**PM2.5**  
PARTICLE SENSOR

## The smart air purifier that breathes clean air

Appearance matters. That's why Tube is not only extremely powerful, but also an eyecatcher in any room. Its capacity of 550m<sup>3</sup> per hour Clean Air Delivery Rate enables it to clean the air in a room of up to 110m<sup>2</sup> in just 30 minutes. The Duux Smart app ensures easy operation – or simply use the buttons.

### Looking after your health

Thanks to its PM2.5 sensor, Tube turns on automatically when the air quality is poor. It has 3 speeds and a 1 to 8-hour timer mode, shutting down automatically according to your wishes. Its ionizer can be operated separately, and the filter lifespan indicator alerts you when the filter needs replacing.

## Features and specifications

- LCD display
- PM2.5 sensor
- Air quality indication
- Filter replacement indicator
- Triple stage filtration
- Humidity and temperature indication
- 3 speed settings
- 1, 2, 4 and 8h timer modes

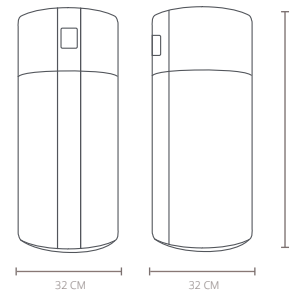



DXPU06 Black | DXPU07 White

# Bright

SMART AIR PURIFIER

## Breathe in, the future is Bright.

Walking, driving, biking, you are constantly surrounded by the invisible enemy: air pollution. Until you cross your doorstep and breathe: clean, pure, Bright. The all new Bright Smart Air Purifier captures 99.97% of impurities, helping even the worst asthma and allergy sufferers. Stylishly compact and portable, it connects to the free Duux Smart app.



200M<sup>3</sup>  
PER HOUR  
CADR

40M<sup>2</sup>  
MAX. EFFECTIVE  
AREA

32dB  
WHISPER  
QUIET

### A big impact with a small footprint

Bright's HEPA H13, activated carbon and pre-filter remove up to 99.97% of air impurities in rooms up to 27m<sup>2</sup>. The highly efficient built-in ionizer accelerates the cleaning process to capture even the tiniest dust particles, chemicals, pollutants and allergens.

## Features and specifications



LED touch display



Built-in ionizer



Air quality indication



Filter replacement indicator



PM2.5 sensor



3 speed settings



Triple stage filtration



2, 4, 6 and 8 hour timer modes

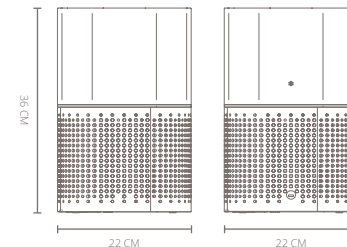

SMART HOME  
COMPATIBLE



# Sphere

AIR PURIFIER



## Your personal air purifier

Keep your personal surroundings clean and save space in style: that is what Sphere is all about. The built-in ionizer releases negative ions into the air to capture tiny particles and pull them into the HEPA filter to produce clean air. The activated carbon also removes harmful gasses and unpleasant smells like tobacco smoke.

68M<sup>3</sup>  
PER HOUR  
CADR

14M<sup>2</sup>  
MAX. EFFECTIVE  
AREA

32dB  
WHISPER  
QUIET

### Aromatherapy

Besides removing, Sphere can also add to the air as it doubles as a vaporizer for essential oils! Just add a couple of drops of aromatherapy to the oil tank and enjoy relaxing aromas throughout the room.

## Features and specifications



Compact design



Built-in ionizer



Up to 68m<sup>3</sup> air flow per hour



Oil tank for aromatherapy



LED mood light



Low power consumption



HEPA + Carbon filter



Whisper quiet operation

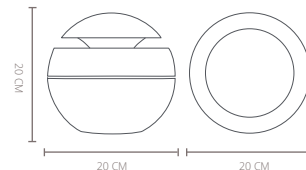

# Duux Smart app

COMPATIBLE WITH VOICE ASSISTANTS

Connect your air treatment device and monitor the quality of your indoor air in real-time. The app allows you to remote control and program your devices from all over the world! And with voice assistant compatibility, you can use your voice to control your Duux with Alexa or Google Assistant.



*Watch the video*

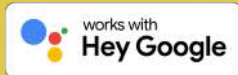
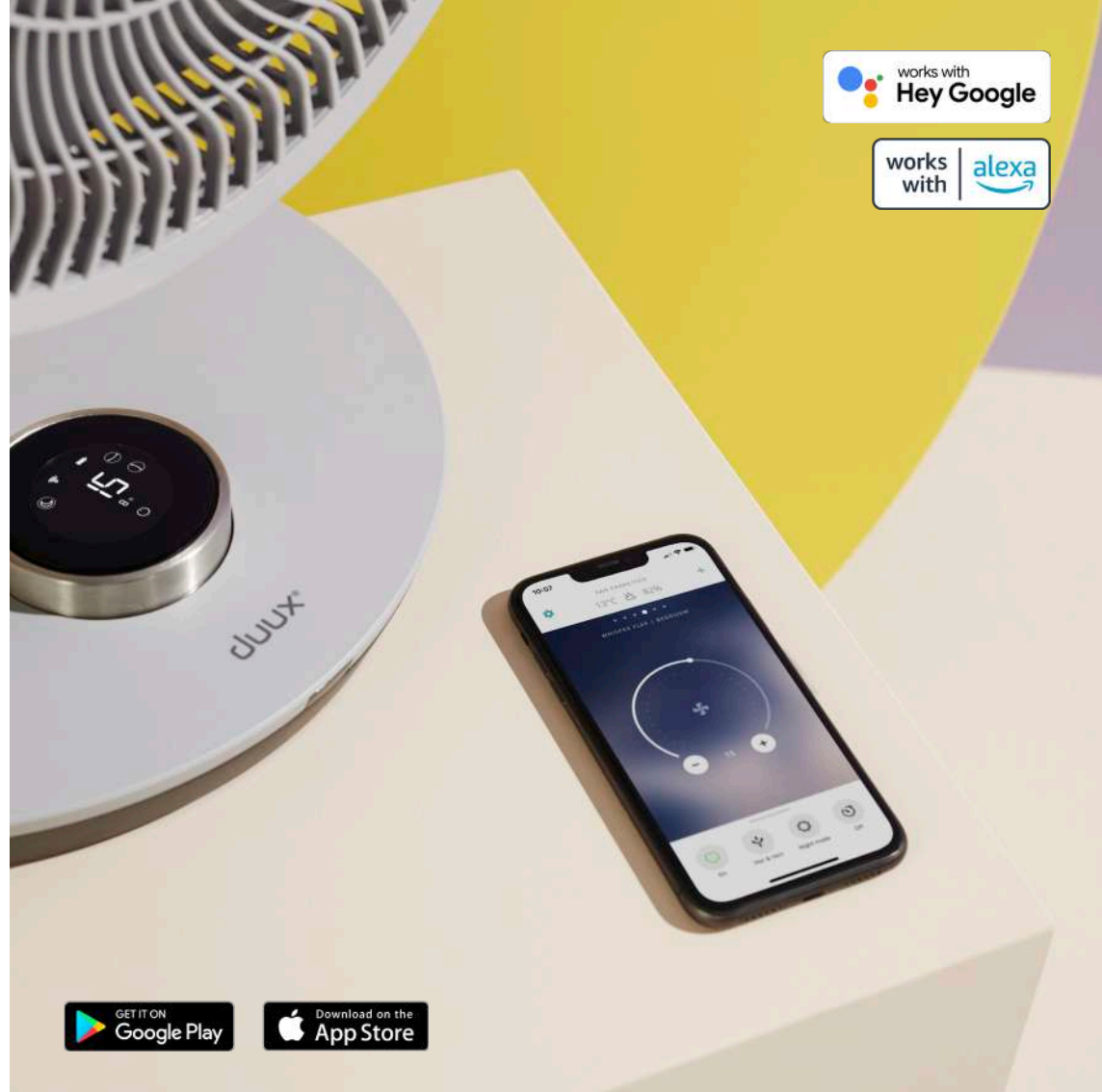

# MOBILE AIR CONDITIONERS

Not sure? Use our decision aid tool:



	Blizzard 10K / 12K ○	North 9K ●	North 12/14/18K ●○
Article no.	DXMA04/05	DXMA22	DXMA10/11/12/13/26
Filter	Activated carbon filter	PET filter	PET filter
Air flow	440 / 410 m <sup>3</sup> per hour	340 m <sup>3</sup> per hour	380 / 380 / 450 m <sup>3</sup> per hour
Noise level	54-60 dB	40-50 dB	52-58 / 55-65 dB
Effective area	Up to 44 m <sup>2</sup>	Up to 33 m <sup>2</sup>	Up to 44 / 51 / 65 m <sup>2</sup>
Cooling performance	3000W / 3400W	2300W	3500 / 4000 / 5000W
Cooling capacity	10.000 / 12.000 BTU/h	9.000 BTU/h	12.000 / 14.000 / 18.000 BTU/h
Dehumidification	28L / 33 L day	24 L day	30 / 36 / 43 L day
Operation modes	4 incl. night mode	5 incl. night mode	4 incl. night mode
Timer	1-24 hours	1-24 hours	1-24 hours
Heating mode	-	✓	-
Remote control	✓	✓	✓
App control	✓	✓	✓
Power consumption	1 - 1150 / 1350W	100 - 1000W	100 - 1538 / 2000W
Dimensions	35,2 x 39,4 x 84,6 cm	44 x 36 x 69,7 cm	44 x 36 x 69,7 cm (12/14K) 48,9 x 36 x 76,3 cm (18K)
Weight	24,5 / 26,5 kg	27 kg	31 / 33 kg
Other specifications	- Eco-friendly R290 gas - Energy class A	- Eco-friendly R290 gas - Energy class A - Automatic swing	- Eco-friendly R290 gas - Energy class A - Automatic swing

# FANS



	Whisper Flex Ultimate ●○	Whisper Flex ●●○	Whisper ○●
Article no.	DXCF14/15	DXCF10/11/12/13/19/20	DXCF03/09
Adjustable height	Yes (58-103 cm)	Yes (51-88 cm)	Yes (76-95 cm)
Air flow	820m <sup>3</sup> /hour	710m <sup>3</sup> /hour	710m <sup>3</sup> /hour
Noise level	13-50 dB	13-50 dB	13-50 dB
Wind reach	17 meters	15 meters	15 meters
Oscillation	Horizontal & vertical	Horizontal & vertical	Horizontal & vertical
Speeds	30	26	26
Timer	1-12 hours	1-12 hours	1-12 hours
Temperature sensor	✓	-	-
Control panel	Rotary knob + LCD screen	Rotary knob + LCD screen	Rotary knob + LCD screen
Remote control	✓	✓	✓
App control	✓	✓	-
Power consumption	3-32W	3-27W	3-26W
Battery pack	✓	Optional (DXCF10/11/19) Included (DXCF12/13/20)	-
Dimensions	34 x 34 x 58-103 cm	33 x 33 x 51-88 cm	34 x 34 x 73-95 cm
Weight	4 kg	5 kg	4,3 kg
Other specifications	- Natural wind and night mode - 3 intermediate angles for oscillation	- Natural wind and night mode	- Natural wind and night mode

# AIR PURIFIERS

Not sure? Use our decision aid tool:



Tube



DXPU03



Bright



DXPU06/07



Sphere



DUAP01/02

Article no.	DXPU03	DXPU06/07	DUAP01/02
CADR	550m³/hour	200m³/hour	68m³/hour
Filter	Pre-, HEPA H13, Activated carbon	Pre-, HEPA H13, Activated carbon	HEPA, Activated carbon
Air quality indicator	✓	✓	-
Noise level	32-64 dB	32-54 dB	< 32dB
Effective area	up to 110m²	up to 40m²	up to 14m²
Speeds	3 + Auto	3 + Auto	1
Timer	1, 2, 4 & 8 hours	2, 4, 6 & 8 hours	-
PM2.5 sensor	✓	✓	-
Filter replacement indicator	✓	✓	-
Control panel	Buttons	Touch	Buttons
Remote control	-	-	-
App control	✓	✓	-
Power consumption	10-55W	10-55W	0-2W
Dimensions	32 x 32 x 68 cm	22 x 22 x 36 cm	20 x 20 x 20 cm
Weight	7,8 kg	3,5 kg	1 kg
Other specifications			-Night light - Suitable for aromatherapy





# Accessories

MAINTAIN OR UPGRADE YOUR DUUX



## Bundel met dock & battery pack

FOR WHISPER FLEX  
(ULTIMATE)

Turn your Whisper Flex (Ultimate) into a completely wireless fan with this dock & battery pack. The battery pack lasts up to 12 hours, depending on the settings.

Battery type – Lithium-ion  
Capacity – 6300 mAh (46.62Wh)

Art. no DXCFBP02

## Whisper family storage bag

FOR WHISPER FAM.

Ready to store your Whisper (Flex) after summer? Prevent scratches and damage with this protective storage bag. The bag is made of light woven material which fits perfectly around your Whisper (Flex). You can tighten the cover at the top with a drawstring to ensure a tight fit.

Art. no DXCFSB01  
(for Whisper & Whisper Flex)  
Art. no DXCFSB03  
(for Whisper Flex Ultimate)

## North family storage cover

FOR NORTH FAM.

Ready to store your North after summer? Prevent scratches and damage with this protective storage cover. The storage cover is made of flexible nylon material so it fits perfectly around your North. The accessory pouch attached with Velcro fits all accessories.

Art. no DXMASC01  
(for North 9/12/14K)  
Art. no DXMASC03  
(for North 18K)





### HEPA H13 + Activated carbon filter

#### FOR TUBE

Replacement filter for Tube air purifier consisting of HEPA H13 + Activated carbon. Up to 99,97% removal efficiency, 4500 hours lifespan (depending on use and air quality). Removes PM2.5 (fine dust), Volatile Organic Compounds, dust, smoke, pollen, pet dander, mould, chemicals, viruses and bacteria.

Art. no DXPUF03

#### FOR BRIGHT

Replacement filter for Bright air purifier consisting of HEPA H13 + Activated carbon. Up to 99,97% removal efficiency, 1500 hours lifespan (depending on use and air quality). Removes PM2.5 (fine dust), Volatile Organic Compounds, dust, smoke, pollen, pet dander, mould, chemicals, viruses and bacteria.

Art. no DXPUF06

### HEPA + Activated carbon filter

#### FOR SPHERE

Replacement filter for Sphere air purifier consisting of HEPA + Activated carbon. 90-99,97% removal efficiency, 3000 hours lifespan (depending on use and air quality). Removes PM2.5 (fine dust), Volatile Organic Compounds, dust, smoke, pollen, pet dander, mould, chemicals, viruses and bacteria.

Art. no DUAPF01



**Duux BV**

P.O. Box 145 | 5400 AC | Uden | The Netherlands  
info@duux.com | www.duux.com

Designed in the Netherlands by Duux BV.

All rights reserved. Duux® is a trademark of Duux BV, registered in the EU and other countries.

The brand cited belongs exclusively to the respective owners. Specifications are subject to modification without notice. Brochure contents may differ slightly from that shown.

This brochure is made from 100% recycled material.

